

# 2026 HOMER NEW LIST PRODUCTS

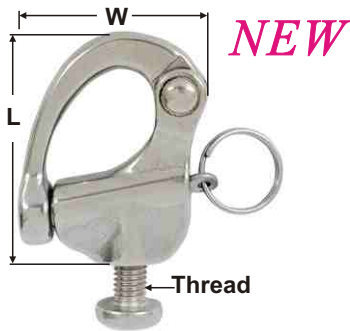

**RING ON PLATE** AISI 316  
Ring:50mm  
ITEM NO. **B25-004**



**SNAP SHACKLE WITH SCREW** AISI 316 (A4)  
ITEM NO. Thread L mm W mm Weight/g  
**004213** M6 40 35 40  
**004214** M8 52 46 90  
**004215** M10 72 57 270



**LOCKABLE SWIVEL FASTENER** AISI 316  
ITEM NO. L mm W mm H mm Weight/g  
**B25-013** 82 24 12 80

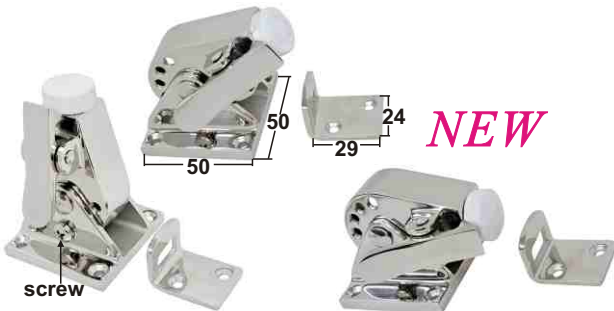

**ADJUSTABLE DOOR HOLDER WITH FLUSH MOUNT PLATE** AISI 316  
Take off screw can adjustable angle  
ITEM NO. Base mm Weight/g  
**B25-020** 50x50 260



**LELTASEN EYELETS** AISI 316  
For refills and pods, for screwing on with ms countersunk holes or with M10 screw-in threaded bolts  
ITEM NO. D mm D1 mm H mm Weight/g  
**B25-014** 18 18 34 104



**HANGER** AISI 316  
ITEM NO. L mm L1 mm W mm H mm Weight/g  
**B25-015** 38 24 30 19 30

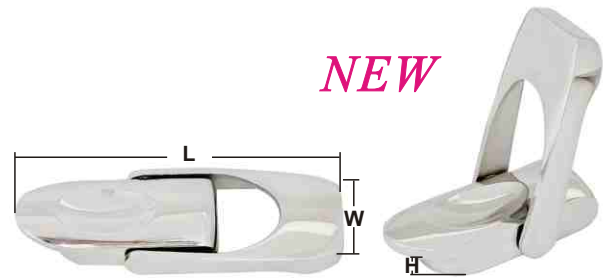

**STAINLESS STEEL LEVER CLOSURE FOR TIGHTLY CLOSING HATCHES** AISI 316  
Lever lock made of highly polished AISI 316, which is suitable for various applications and securely closes any storage box.  
When the closure is open, the closure hook rotates 180° so that it cannot be accidentally bumped.  
ITEM NO. L mm W mm H mm Weight/g  
**B25-012** 81 26 11 60



**DOOR HOLDER WITH MOUNT PLATE** AISI 316  
 ITEM NO.  $\Phi$ mm H mm Weight/g  
**B25-021** 57 66 240



**DOME HIDDEN MINI CLEAT** AISI 316  
 ITEM NO. Base mm  $\Phi$ mm L mm L1 mm Weight/g  
**B25-011** 53x45 19 62 102 250

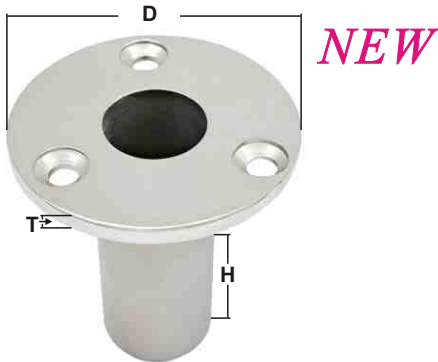

**TARP TUBE HOLDER COUNTER SUNK** AISI 316  
 ITEM NO. For tube  $\Phi$ mm D mm H mm T mm Weight/g  
**B25-016** 20 63.5 64 4 210  
**B25-017** 22 63.5 64 4 200  
**B25-018** 25 70 64 4 300  
**B25-019** 30 70 64 4 310



**FLAG POLE WITH BASEMENT 45°** AISI 316  
 Staffs come completely with stainless steel  
 the pole of sockets is 60cm(23-1/2")  
 the basement:85mmx40mm(3-3/8"x1-9/16")  
 ITEM NO. Weight/g  
**B25-008** 530



**STAINLESS STEEL PIPE** AISI 304  
 ITEM NO. Dia Length Thickness  
**B24-043** 22mm 600cm 1.5mm  
**B24-044** 25mm 600cm 1.5mm



**VENT** casted AISI 316  
 Heavy duty  
 ITEM NO. L mm W mm Weight/g  
**B25-009** 97 97 220



**VENT** casted AISI 316  
 Heavy duty  
 ITEM NO. L mm W mm Weight/g  
**B25-010** 129 129



**NEW**

**3 NARROW STEP DOVER PLAT FORM TELESCOPING DROP LADDER AISI 316  
GOOD FOR RUBBER BOAT**

steps-fold out and over telescope down easily compact  
stowage-steps fold over flat on platform flat poly treads are  
attached to steps for comfort mounting hard ware and quick  
lock nylon strap included

ITEM NO.	Length Deployed	Length stowed	Height	Width	Bracket Length
<b>B25-024</b>	34" (86cm)	14.5" (37cm)	15" (38cm)	6" (15cm)	24.5cm



**NEW**

**STARLINK ADAPTER AND RATCHET BASE** casted AISI 316

Starlink 316 stainless steel adapter  
to mount to a 1"-14 thread  
Bottom of the adapter has 1"-14 threads  
and comes with locking nut  
Top of the adapter is machined to fit the  
starlink antenna post  
The overall height is 19cm  
(adapter with the ratchet base)  
Base measures 65mm(2-1/2")x92mm(3-9/16")  
with 4 holes for 1/4" bolts with 3/8" hole  
for cable pass through

ITEM NO. **B24-027**

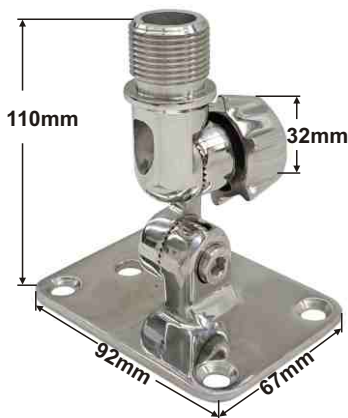

**NEW ANTENNA RATCHET MOUNTS** casted AISI 316

Thread 1"-14

ITEM NO. **B22-019**



**NEW**

**STAINLESS STEEL PEDESTAL MOUNT** AISI 316  
for TV, VHF Ioran and GPS antennas  
and shorter antennas

ITEM NO.	Thread	Weight
<b>B25-002</b>	1"-14tpi	120g



**INSPECTION PORT PLASTIC** (white color)  
inside with sealing rubber O-ring  
clear cover made of polycarbonate  
ITEM NO.  $\Phi$

**B24-020** 152mm(6")



**INSPECTION PORT STAINLESS  
FRAME WITH CLEAR COVER**  
inside with sealing rubber O-ring  
clear cover made of polycarbonate  
stainless frame is AISI 316  
ITEM NO.  $\Phi$

**B24-022** 152mm(6")

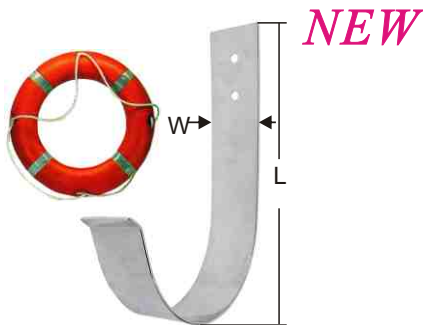

**LIFE BUOY BRACKET** stamped AISI 304

ITEM NO.	LxW mm	Thickness	Weight/g
<b>B24-001</b>	210x40	2 mm	210

**B24-001** 210x40 2 mm 210

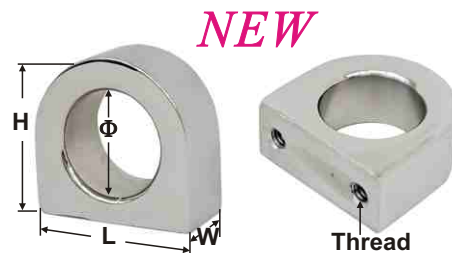

**EYEBOLTS AND RINGS**

towing/lifting rings AISI 316  
ITEM NO. L mm H mm W mm Mounting with  
**B24-006** 38 35 15.6 M5 thread



**PULL DRAIN PLUGS AND SLEEVES**

ITEM NO.	Drainage hole	Weight/g
<b>B24-013</b>	32mm(1-1/4") AISI 316	50

**B24-013** 32mm(1-1/4") AISI 316 50



**GARBOARD DRAIN PLUG** casted AISI 316  
Thread, removable plug highly polished.

ITEM NO.	L mm	L1 mm	B mm	Weight/g
<b>B17-002</b>	54	24	12	90

**B17-002** 54 24 12 90



**STRUT HOLDER** AISI 316

ITEM NO.	Φmm	Φ1mm	H mm
<b>B24-002</b>	73(2-13/16")	38(1-1/2")	70(2-3/4")

**B24-002** 73(2-13/16") 38(1-1/2") 70(2-3/4")



**30° DECK FILL & TANK VENT** casted AISI 316  
has a vent with a flame arrester into grated  
in the fill flange.

ITEM NO.	ΦDia mm	O.D. mm	Marking	Weight
<b>B24-016</b>	38(1-1/2")	82(3-3/16")	FULL	510g
<b>B24-017</b>	38(1-1/2")	82(3-3/16")	DIESEL	510g
<b>B24-018</b>	38(1-1/2")	82(3-3/16")	WATER	510g
<b>B24-019</b>	38(1-1/2")	82(3-3/16")	WASTE	510g

**B24-019** 38(1-1/2") 82(3-3/16") WASTE 510g

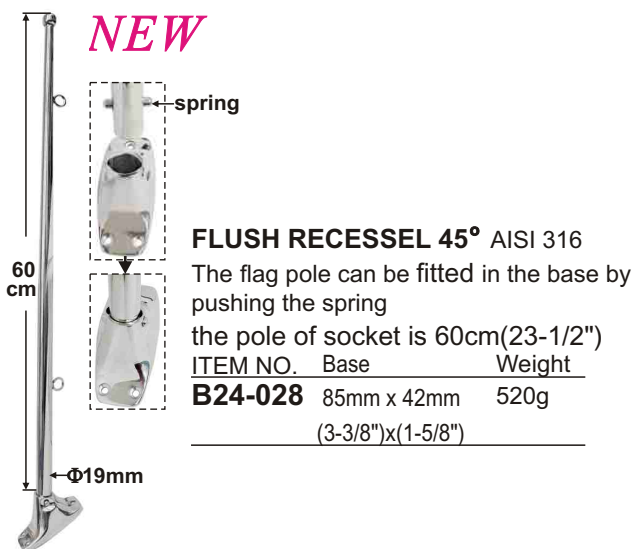

**NEW**

**FLUSH RECESSEL 45° AISI 316**  
 The flag pole can be fitted in the base by pushing the spring  
 the pole of socket is 60cm(23-1/2")  
 ITEM NO. Base Weight  
**B24-028** 85mm x 42mm 520g  
 (3-3/8")x(1-5/8")

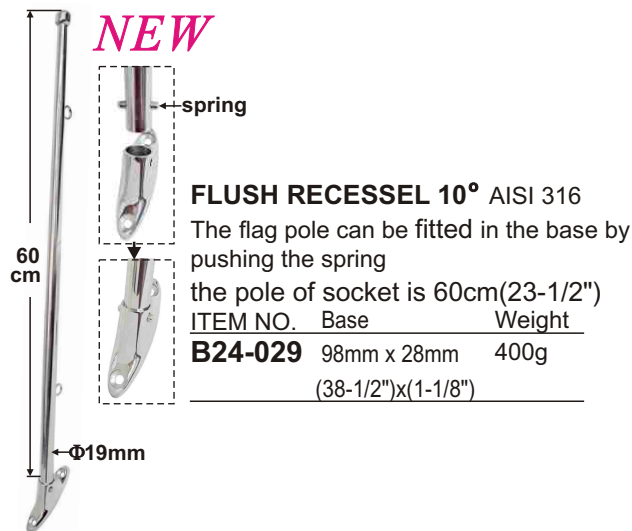

**NEW**

**FLUSH RECESSEL 10° AISI 316**  
 The flag pole can be fitted in the base by pushing the spring  
 the pole of socket is 60cm(23-1/2")  
 ITEM NO. Base Weight  
**B24-029** 98mm x 28mm 400g  
 (38-1/2")x(1-1/8")



**NEW**

**FLUSH MOUNT ROD HOLDER WITH BILGE EXIT** 90 degrees AISI 316 marine quality. Lined with white pvc to protect rod handle with plastic adapter, bilge exit connected to bilge exit a water pipe the water pipe can be put outside deck to keep the deck dry.  
 ITEM NO.  $\phi$ mm L mm  
**B24-008** 50 220



**NEW**

**FLUSH MOUNT ROD HOLDER WITH BILGE EXIT** 15 degrees AISI 316 marine quality. Lined with white pvc to protect rod handle with plastic adapter, bilge exit connected to bilge exit a water pipe the water pipe can be put outside deck to keep the deck dry.  
 ITEM NO.  $\phi$ mm L mm  
**B24-009** 50 220



**NEW**

**FLUSH MOUNT ROD HOLDER WITH BILGE EXIT** 30 degrees AISI 316 marine quality. Lined with white pvc to protect rod handle with plastic adapter, bilge exit connected to bilge exit a water pipe the water pipe can be put outside deck to keep the deck dry.  
 ITEM NO.  $\phi$ mm L mm  
**B24-004** 50 220



**NEW**

**FLUSH MOUNT ROD HOLDER WITH BILGE EXIT** 30 degrees AISI 316 marine quality. Lined with white pvc to protect rod handle with plastic adapter, bilge exit connected to bilge exit a water pipe the water pipe can be put outside deck to keep the deck dry.  
 ITEM NO.  $\phi$ mm L mm  
**B24-010** 50 220



**FISHING ROD HOLDER** casted AISI 316

Installation on rails

Length:250mm(10") I.D.:50mm(2")

ITEM NO. Rail pipe  $\phi$ mm Weight/g

**B24-023** 22(7/8") 760

**B24-024** 25(1") 770

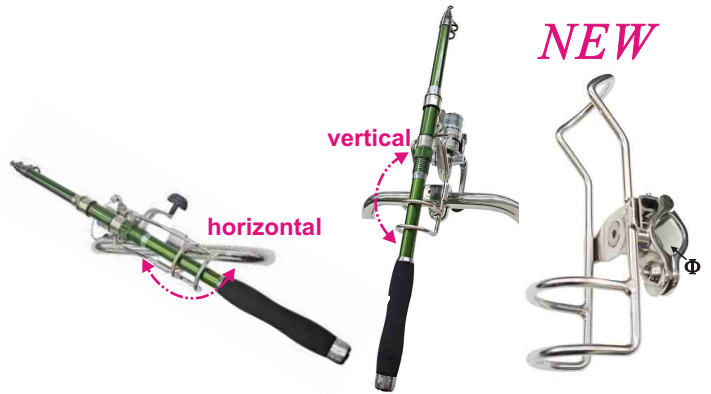

**ECONOMIC FISHING ROD HOLDER RACK** AISI 316

Various angles can be adjusted.

Like vertical or horizontal angle.

ITEM NO. Rail pipe  $\phi$ mm Weight/g

**B24-011** 25 370

**B24-012** 22 360



**HOLDER FOR RESCUE DEVICE** AISI 304

fit  $\phi$ 22mm tube rail

ITEM NO. Size Weight/g

**B24-026**  $\phi$ 110mmx240mm 250



**PIPE FIT PLASTIC CLIP**

For attaching the fender basket on search land or pulpit to pipe with  $\phi$ 22~25

Consumption:2-3 brackets for 2-3 baskets, depending on installation

ITEM NO. **B24-038**

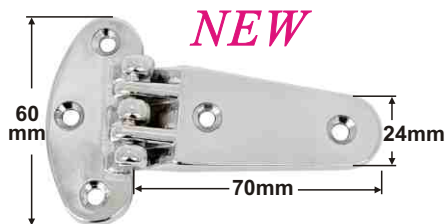

**HATCH HINGE** AISI 316

ITEM NO. stop mm Weight/g

**B24-037** 8 78

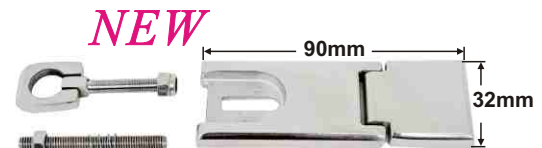

**HASP & STAPLE**

Made of AISI 316

The padlock ring can swivel and fold and fitted with padlock ring.

It's aligned and doesn't disturb when is set on top. univeral studmounting.

Weight:100g

ITEM NO. **B24-040**



**HATCH HINGE** AISI 316

Good for hatch opening

ITEM NO. Length Weight/g

**B24-039** 110 mm 150

# 2025 HOMER NEW LIST PRODUCTS

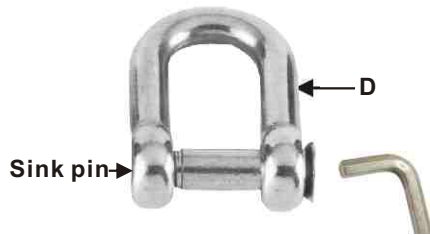

**D SHACKLE WITH OVAL SINK PIN** AISI 316

ITEM NO.	D mm	BL/KG	Weight/g
<b>003406</b>	6(1/4")	1800	22
<b>003408</b>	8(1/3")	3500	45
<b>003410</b>	10(2/5")	5400	100

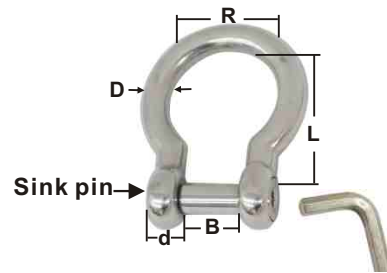

**BOW SHACKLES WITH OVAL SINK PIN** AISI 316

ITEM NO.	D mm	B mm	R mm	d mm	L mm	BL/KG	Weight/g
<b>001306-P</b>	6(1/4")	12	21	12	24	1500	29
<b>001308-P</b>	8(5/16")	16	28	16	32	2300	73
<b>001310-P</b>	10(13/32")	20	34	20	40	3700	136

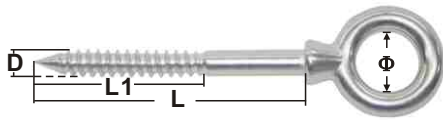

**SCREW EYES** AISI 316

Eye with screw thread is ideal for balustade ends into wooden poles and for other applications

ITEM NO.	D	L mm	L1 mm	Φ mm
<b>001800</b>	5	50	30	11
<b>001801</b>	6	60	35	14
<b>001802</b>	8	80	50	18
<b>001803</b>	10	100	60	22



**WOOD SCREW EYE RING** AISI 316

ITEM NO.	D	D1	L mm	L1 mm	Φ mm
<b>001816</b>	5	6	50	30	35
<b>001817</b>	6	6	60	35	35
<b>001818</b>	8	8	80	50	45
<b>001819</b>	10	8	100	60	50



**SAFETY JAW AND JAW SWIVEL** AISI 316

ITEM NO.	Size	L mm	B mm	C mm	D mm	BL/KG	Weight/g
<b>000317</b>	6	66	12	11	6	1350	61
<b>000318</b>	8	94	16	16	8	2500	160
<b>000319</b>	10	118	20	22	10	3500	320



**DECK PLATE WITH SWIVEL SNAP SHACKLE** AISI 316

ITEM NO.	A mm	L mm	W mm	Weight/g
<b>003684</b>	16	75	28	110
<b>003688</b>	21	95	35	270

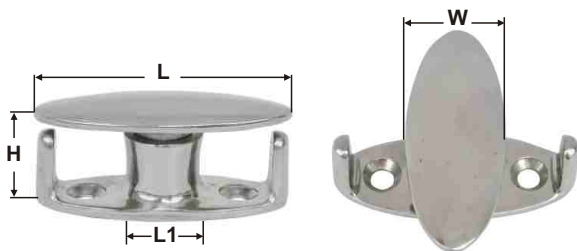

**FENDER HALTER MIT DREHVERSCHLUSS** AISI 316

Swivel fender holder

ITEM NO.	L mm	L1 mm	H mm	W mm	weight/g
<b>B22-005</b>	63	18	27	25	120



**SECURE CLIPS** AISI 316

For turnbuckle, packing 4pcs in one p.p bag

ITEM NO.	Turnbuckle	Weight/g (for 4pcs)
<b>008020</b>	for 5/16"	
<b>008021</b>	for 3/8"	
<b>008022</b>	for 7/16"	
<b>008023</b>	for 1/2"	
<b>008024</b>	for 5/8"	

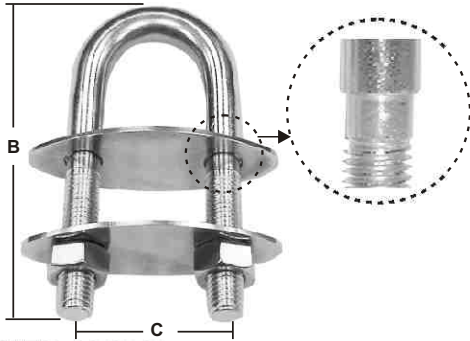

**U BOLTS** AISI 316

With oval plate

ITEM NO.	Thread	B mm	C mm	Weight/g
<b>005747</b>	M12	120	47	340

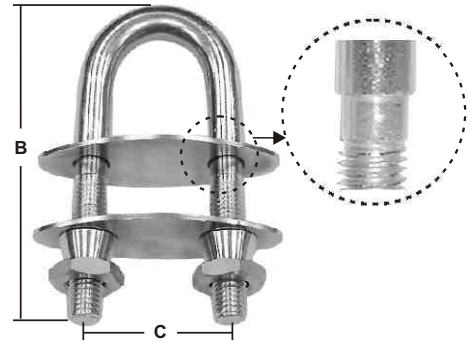

**SECURITY U BOLTS** AISI 316

With oval plate

ITEM NO.	Thread	B mm	C mm	Weight/g
<b>005750</b>	M12	120	47	350



**U BOLTS WITH NYLON LOCK NUTS** AISI 316

ITEM NO.	Thread	B mm	C mm	Weight/g
<b>005757</b>	M12	120	47	360



**FAIRLEADS** AISI 316

With oval plate

ITEM NO.	Thread	B mm	C mm	Fixing mm	Weight/g
<b>005733</b>	M6	80	35	6	81

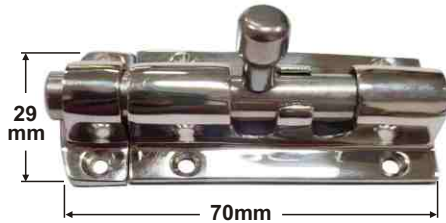

**STAINLESS BARREL BOLTS**

precision casted AISI 316

ITEM NO.	Overall
<b>B23-030</b>	70mmx29mm



**STAINLESS BARREL BOLTS**

precision casted AISI 316

ITEM NO.	Overall
<b>B23-029</b>	50mmx29mm



**90° BARREL BOLTS** precision casted AISI 316

ITEM NO.	Overall mm	Weight
<b>008340</b>	55x39(2-3/16"x1-1/2")	100g



**SLIM BARREL BOLT** casted AISI 316

Visible mounting holes integral friction pad eliminates rattle and provides smooth operation.

ITEM NO.	Lmm	Wmm	Weight/g
<b>008319</b>	88	18	60



**SLIM BARREL BOLT** casted AISI 316  
Visible mounting holes integral friction pad eliminates rattle and provides smooth operation.

ITEM NO.	Lmm	Wmm	Weight/g
<b>008311</b>	88	18	60

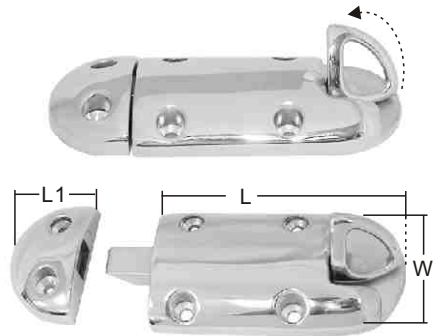

**LOCKING DEVICE WITH SPRING LOADED BOLT** casted AISI 316

ITEM NO.	L mm	L1 mm	W mm	Weight/g
<b>008399</b>	100	35	52	282



**ECCENTRIC LATCH WITH PADLOCK EYE** stamped AISI 304

ITEM NO.	Total length	Width	Travel	Weight/g
<b>008348</b>	82mm	20mm	4.5mm	60

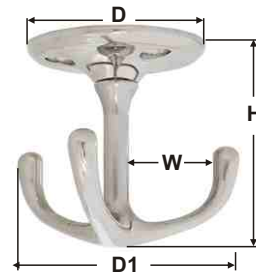

**SWIVELING TRIPLE COAT HOOK** AISI 316

ITEM NO.	D mm	D1 mm	H mm	W mm	Weight/g
<b>B23-025</b>	50	65	57	25	100



**3 BAR MOVEABLE HOOKS** casted AISI 316

ITEM NO.	L mm	W mm	Weight/g
<b>003129</b>	69(2-3/4")	38(1-1/2")	170

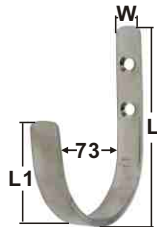

**BOAT HOOK HOLDER WITH LONG HOOK** AISI 304

ITEM NO.	L mm	L1 mm	W mm	Thickness
<b>B19-030</b>	105	65	15	4mm



**HOOK** Casted AISI 316 with rubber cord

Small tools for the practical suspension of ropes

ITEM NO.	Length	Weight/g
<b>003014</b>	72mm	63

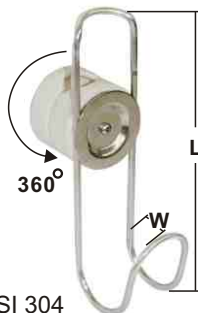

**HOOK** AISI 304 fit  $\phi 25$ mm tube rail

ITEM NO.	L mm	W mm	Weight/g
<b>003017</b>	200	50	220



**DOOR CLAMPS** casted AISI 316

Two versions

ITEM NO. **B23-050**

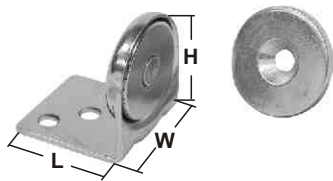

**MAGNETIC CLASPS** stamped AISI 304

For 3/4"(19mm) thick surfaces.

ITEM NO.	Dimensions	Capacity	Weight/g
<b>003687</b>	31mmL x 28mmW x 31mmH 1-1/4"(L) x 1-1/8"(W) x 1-1/4"(H)	18kg (40lb)	



Flush strike

**MAGNETIC DOOR & WINDOW HOLDER**

Casted AISI 316

ITEM NO.	Weight/g
<b>003698</b>	220



**DOOR STOP AND CATCHER 90°**

casted AISI 316

ITEM NO.	L mm	H mm	Φ mm	Weight/g
<b>B19-017</b>	92	52	50	180



**DOOR STOP AND CATCHER**

casted AISI 316

ITEM NO.	Weight/g
<b>B22-009</b>	202



**DOOR LOCK HOOK** casted AISI 316

with double swivel

ITEM NO.	L mm	Weight/g
<b>B19-033</b>	70(2-3/4")	64
<b>B19-045</b>	90(3-9/16")	71
<b>B19-046</b>	120(4-3/4")	77

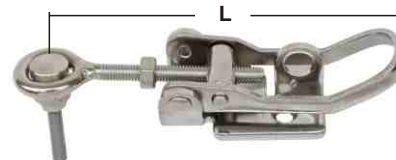

**ECCENTRIC LATCH** stamped AISI 304

ITEM NO. adjustable L mm Weight/g

<b>B19-035</b>	109 ~ 114	110
----------------	-----------	-----



Wall fitting



Door fitting



Packed

**HEAVY DUTY HINGE** casted AISI 316

Packed Wall fitting Door fitting

ITEM NO.	mm	mm	mm	Weight/g
<b>008614</b>	45x30	25x30	20x30	92



**HINGE** casted AISI 316

ITEM NO. L mm B mm Thickness Weight/g

<b>B19-027</b>	85	18	4.5mm	120
----------------	----	----	-------	-----



**LIFT OFF HINGE** stamped AISI 304  
 ITEM NO. Thickness Weight  
**008516** 2.0mm 40g

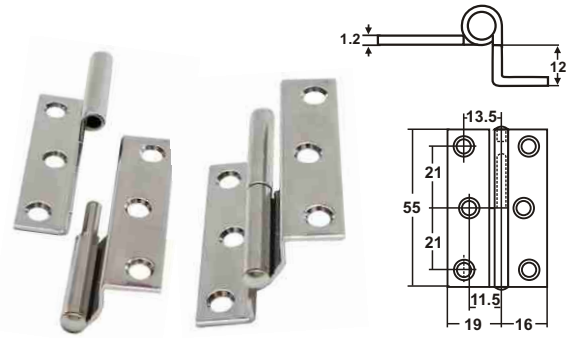

**LIFT OFF HINGE** stamped AISI 304  
 ITEM NO. Note Weight/g  
**B18-015L** Right handed 36  
**B18-015R** Left handed 36

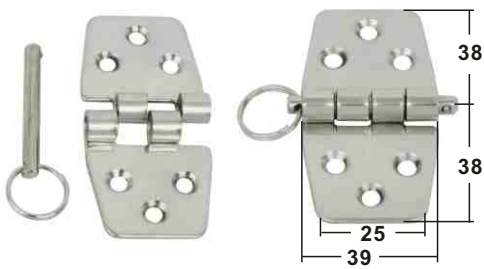

**HINGE WITH PIN** stamped AISI 304  
 ITEM NO. Thickness Weight/g  
**008514** 2mm 50

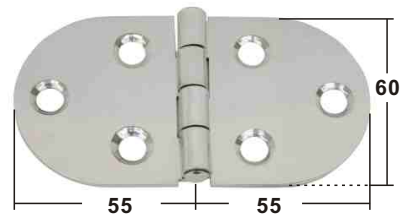

**HINGE** stamped AISI 304  
 ITEM NO. Thickness Weight/g  
**008513** 2mm 95

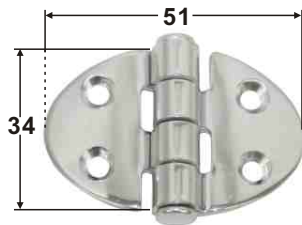

**HINGE** Stamped AISI 316  
 Buff polished  
 ITEM NO. Thickness Weight  
**006134** 2mm 30g

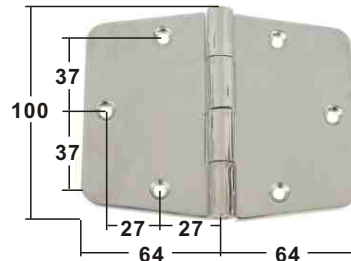

**HINGE** stamped AISI 316 buff polished  
 ITEM NO. Thickness Weight/g  
**006132** 3mm 340



**COVERS WITH HINGES** AISI 304  
 No visible screw, easy to clean  
 ITEM NO. **006138**



**COVERS WITH HINGES** AISI 304  
 No visible screw, easy to clean  
 ITEM NO. **006139**



**COVERS WITH HINGES** AISI 304  
No visible screw, easy to clean  
ITEM NO.006137

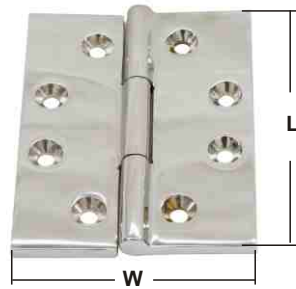

**DOOR HINGE** precision casted AISI 316  
ITEM NO. WxLmm      Thickness      Weight/g  
**008515** 80x100(3-3/16"x4") 4mm      300



**DOOR HINGE** precision casted AISI 316  
Reverse  
ITEM NO. WxLmm      Thickness      Weight/g  
**008512** 38x75(1-1/2"x3") 4.5mm      89

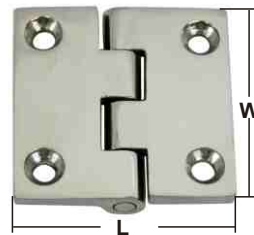

**DOOR HINGE** precision casted AISI 316  
Reverse  
ITEM NO. WxLmm      Thickness      Weight/g  
**008511** 50x50(2"x2") 4.5mm      89



**HINGE** stamped AISI 304  
ITEM NO. Thickness      Weight/g  
**B19-028** 2mm      70



**SAFE SNAP** AISI 316  
Stainless steel,  
It is good for sail boat  
ITEM NO.2431-SS

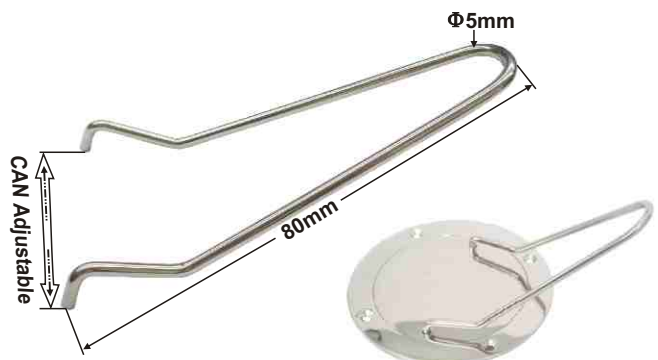

**INSPECTION PORT ADJUSTABLE KEY** AISI 304  
Stainless steel  
Flexible wire you can use one key for  
all kind of inspection ports which is the advantage.  
ITEM NO.B22-001



**DECK FILLER** casted AISI 316

fit for winch handle to close & open.

ITEM NO.	Dia mm	Type	Weight
<b>008887</b>	50(2")	FUEL	680g
<b>008888</b>	50(2")	WATER	680g
<b>008889</b>	50(2")	WASTE	680g
<b>004502</b>	key for deck filler		



**DECK FILL WITH KEY** casted AISI 316

ITEM NO.	O.D. mm	Dia mm	Marking	Weight/g
<b>008893</b>	90	50(2")	GAS	690
<b>008894</b>	90	50(2")	DIESEL	690
<b>008895</b>	90	50(2")	FUEL	690

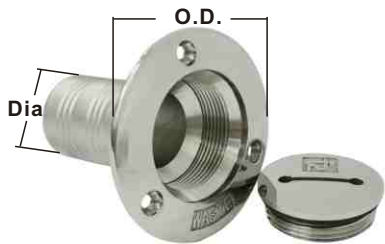

**DECK FILLER (WASTE)** casted AISI 316

According ISO 8099

ITEM NO.	Dia mm	O.D. mm	Weight
<b>008858</b>	38(1-1/2")	85(3-5/16")	470g



**DECK FILLER 45°** casted AISI 316

ITEM NO.	Dia mm	Type	Weight
<b>008930</b>	38(1-1/2")	WASTE	470g
<b>008931</b>	38(1-1/2")	GAS	470g
<b>008932</b>	38(1-1/2")	DIESEL	470g
<b>008933</b>	38(1-1/2")	WATER	470g



**DECK FILL 30°** casted AISI 316

ITEM NO.	Dia mm	Type
<b>B19-010</b>	38(1-1/2")	waste
<b>B19-011</b>	38(1-1/2")	gas
<b>B19-012</b>	38(1-1/2")	diesel
<b>B19-013</b>	38(1-1/2")	water



**FUEL TANK VENT ROUND HEAD** casted AISI 316

straight

ITEM NO.	Hose size	Weight/g
<b>003777</b>	35mm(1-3/8")	180



**FUEL TANK VENT ROUND HEAD** casted AISI 316

straight

ITEM NO.	Hose size	Weight/g
<b>003795</b>	19mm(5/8")	130



**GARBOARD DRAIN PLUG** casted AISI 316

Thread, removeable plug highly polished.

ITEM NO.	Hole mm	L mm	Weight/g
<b>003780</b>	27(1")	64(2-9/16")	110

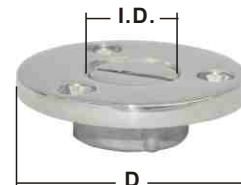

**GARBOARD DRAIN PLUG** casted AISI 316

ITEM NO.	I.D.	D	Weight
<b>003781</b>	17mm	50mm(2")	90g

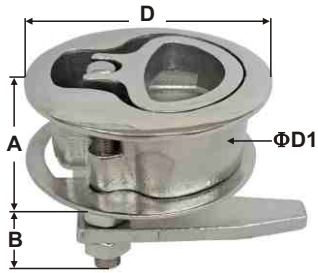

**LIFTING HANDLE** AISI 316  
 ITEM NO. D mm D1 mm A mm B mm weight/g  
**B22-010** 61 51 21 39 280



**LIFT HANDLE LATCH** casted AISI 316  
 Highly-polished  
 ITEM NO. Base mm Weight/g  
**007109** Φ 44(1-3/4") 110



**LIFT HANDLE WITH COVER** casted AISI 316  
 ITEM NO. Weight  
**007179** 350g



**PULL DRAIN PLUGS AND SLEEVES** AISI 316  
 With S.S. chain  
 ITEM NO. Size Weight  
**009688** 25 50g



**INSPECTION PORT** casted AISI 316  
 ITEM NO. I.D. Flange Cut out  
 mm O.Dmm Hole size mm Weight/g  
**B22-007** 75(3") 119(4-11/16") 85(3-3/8") 479  
**B22-008** 100(4") 141(5-9/16") 111(4-3/8") 753

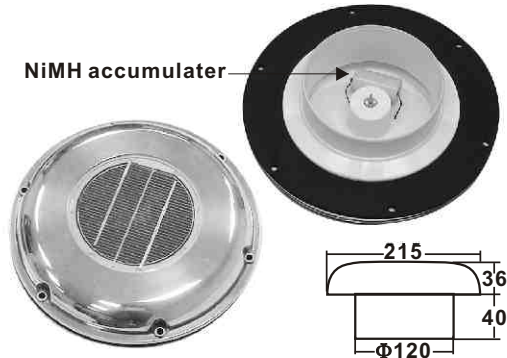

**LOW PROFILE SOLAR VENTS WITH NIMH BATTERY** stainless steel cover, stamped AISI 304  
 It needs rain or shine whether you're on the boat or not. solar cells power the fans for efficient, active ventilation. Low profile. Single crystal solar cells recharge NiMH battery for 24 hours operation.  
 ITEM NO. Basement Weight/g  
**003794** 215mm(8-1/2") 800

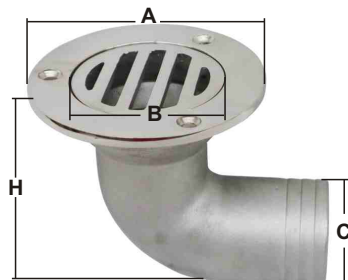

**SHOW / COCKPIT DRAINERS** stainless steel AISI 316  
 ITEM NO. Flange Φ(A) Application hole (B) Hose adaptor (C) H mm Weight/g  
**B19-018** 80 mm 50 mm 38 mm 70 380

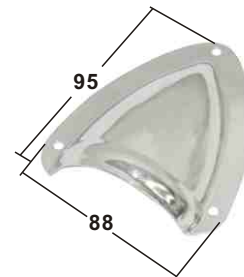

**VENT** AISI 304  
 ITEM NO. LxWxHmm Type Weight/g  
**003751** 95x88x24 midget 50



**VENT WITH THREAD** casted AISI 316  
Heavy duty  
ITEM NO. Lmm x Wmm Thread Weight/g  
**003797** 83 x84 M6 240



**VENT WITH THREAD** casted AISI 316  
Heavy duty  
ITEM NO. Lmm x Wmm Thread Weight/g  
**B23-034** 127(5-1/16")x127(5-1/16") M6 400



**VENT** stamped AISI 304  
ITEM NO. L mm W mm Thickness Weight  
**B19-029** 100 100 1 mm 70g



**ROUND TRANSOM VENT** stamped AISI 304  
ITEM NO. O.D.mm Weight/g  
**003743** 150(6") 140  
**003744** 150(6") back with S.S. net 150  
**003750** 65(2-9/16") 15  
**003752** 65(2-9/16") back with S.S. net 17



**COVER** AISI 304  
For ventilation it fit to item no.003727,  
003703,003706(less ventilation)  
ITEM NO. L mm H mm Weight/g  
**003775** 125 125 63



**BUTTERFLY VENT**  
stamped AISI 304  
ITEM NO.  $\Phi$  mm  
**B23-041** 180



**BUTTERFLY VENT** stamped AISI 304  
ITEM NO.  $\Phi$  mm  
**003740** 150(6")



**POP-UP MINI CLEATS** casted AISI 316  
for small boats.

ITEM NO.	Base mm	Hole mm	Weight/g
<b>003871</b>	89x31	22	260
<b>003874</b>	130x39	34	410



**NO SOUND PULL OUT CLEATS** casted AISI 316

ITEM NO.	Length mm	Thread	Weight/g
<b>B23-036</b>	155(6-1/8")	M10	540



**MINI LOW FLAT CLEAT** with 2 holes AISI 316

ITEM NO.	Length mm	Inch	Weight
<b>003891</b>	80	3-3/16"	39g



**FOLDING CLEATS** casted AISI 316

Folding cleats with recessed screw do not require a cutout.

ITEM NO.	Length mm	Weight
<b>003876</b>	85(4-3/8")	210g



**FOLDING CLEATS** casted AISI 316

Folding cleats with recessed screw do not require a cutout.

ITEM NO.	Length mm	Weight
<b>003892</b>	120(4-3/4")	200g
<b>003889</b>	155(6-1/8")	500g



**FOLDING CLEATS WITH THREAD** casted AISI 316

ITEM NO.	Length mm	Thread
<b>B19-004</b>	120(4-3/4")	M10
<b>B19-005</b>	155(6-1/8")	M10



**PULL OUT CLEATS** casted AISI 316

ITEM NO.	Length mm	Thread	Weight
<b>B19-006</b>	150(6")	M10	490g
<b>B19-007</b>	200(8")	M10	



**PULL OUT CLEATS** casted AISI 316

With stainless steel counter plate and thread

ITEM NO.	Length mm	Thread
<b>B19-015</b>	150(6")	M10
<b>B19-016</b>	200(8")	M10



**SINGLE LEAD BLOCK** AISI 304  
 For rope  $\Phi$ 8mm  
 plastic sheaves 30x11mm  
 ITEM NO. Weight/g  
**B23-049** 31

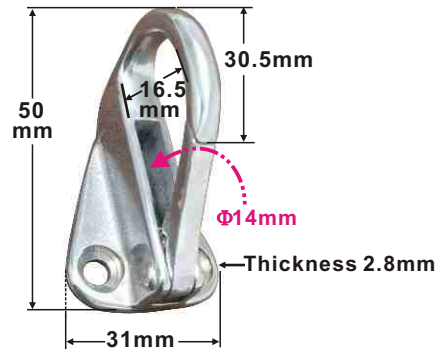

**FENDER HOOK WITH SAFTY SNAP** AISI 316  
 ITEM NO. **B23-009**

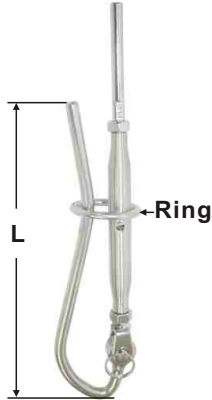

**FORESTAY TENSIONNER WITH RING** AISI 304  
 Not include turnbuckle & swadge terminal  
 ITEM NO. L mm Ring  $\Phi$ mm(inside) Wire  $\Phi$ mm  
**004900** 115 30 6  
**004901** 105 33 8  
**004902** 220 40 10  
**004903** 260 46 12



**DOUBLE FOLDING PAD EYE** AISI 316  
 Fold down when not in use double ring  
 ITEM NO. Ring Breaking load Weight/g  
**003692** 10mm 9000 kg



**ANCHOR HOLDER** AISI 316  
 Adjustable max 15kg  
 ITEM NO. L mm W mm Weight  
**073507** 540 150 3.0kg



**HEAVY DUTY ROUND PAD EYES** AISI 316

ITEM NO.	Base Dia	Inside Dia	Ring Dia	Weight/g
<b>003693</b>	58mm (2-1/4")	17mm (11/16")	9.5mm (3/8")	6000kg(13200Lb)

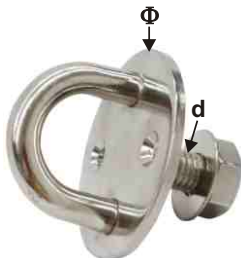

**EYE PLATE with WASHER & NUT**  
 stamped AISI 304  
 ITEM NO.  $\Phi$ mm Thickness d mm Weight/g  
**003590** 33 2.5mm M6 28  
**003591** 40 2.5mm M8 50  
**003592** 50 3.0mm M10 90



**ROUND EYE PLATE WITH THREAD AND RING** AISI 304  
 ITEM NO.  $\Phi$ mm Thickness d mm Ring Weight/g  
**B19-024** 33 2.5mm M6 5x30 40  
**B19-025** 40 2.5mm M8 6x35 70  
**B19-026** 50 3.0mm M10 8x45 140



**ROUND RING WITH PLATE** stamped AISI 304  
 ITEM NO. L mm B mm Ring mm Weight/g  
**B19-039** 70 40  $\Phi$  10x80 290

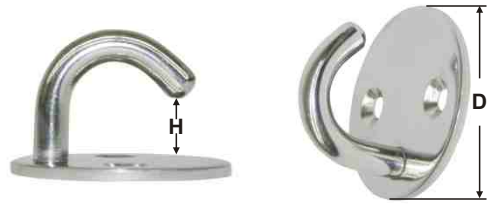

**ROUND PLATE HOOKS** stamped AISI 304  
 ITEM NO. D mm H mm Thickness Weight/g  
**003695** 33 9 2.5mm 20  
**003696** 40 9 2.5mm 40  
**003697** 50 15 3.0mm 60

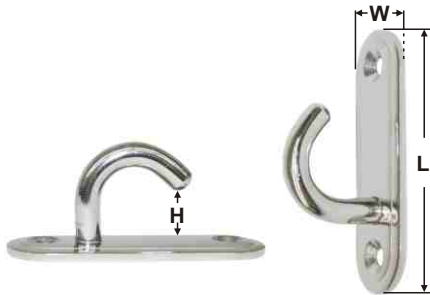

**PLATE HOOK** stamped AISI 304  
 ITEM NO. L mm W mm H mm Weight/g  
**003597** 45(1-49/64") 15(5/8") 9 15  
**003598** 60(2-23/64") 20(25/32") 13 30  
**003599** 80(3-5/32") 25(1") 15 60



**EYE PLATE WITH FIXED RING**  
 stamped AISI 304  
 ITEM NO. L mm B mm Ring mm  
**B18-013** 70 40  $\Phi$ 8x45

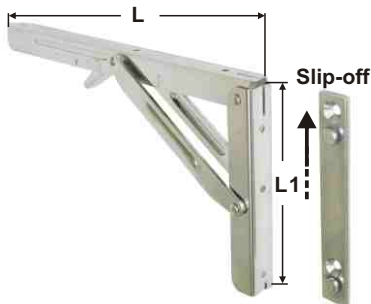

**SLIP-OFF FOLDABLE ARMS** stamped AISI 304  
 For table can be slipped off their wall support.  
 Load up to 150kg  
 ITEM NO. L L1 Weight/g  
**006135** 303mm(12") 165mm(6-1/2") 650

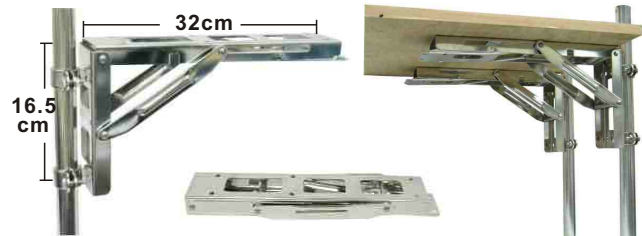

**BRACKET ASSEMBLY** stainless steel  
 Folding bracket for table and working plates.  
 Very stable, load up to 150kg. the set consists of 2 brackets, 4 clips (22-25mm tube) and 4 screw with nuts.  
 ITEM NO. **006131**

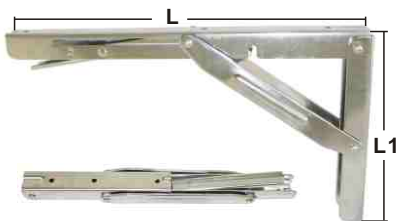

**FOLDING BRACKET** stamped AISI 304  
 For tales and working plates, Load up to 150kg  
 ITEM NO. L L1 Weight/g  
**006133** 303mm(12") 165mm(6-1/2") 530

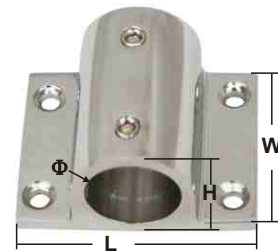

**TUBE HOLDER** casted AISI 316  
 ITEM NO. For tube  $\Phi$  L mm W mm H mm Weight  
**B19-019** 22 mm 58 46 29 160g  
**B19-020** 25 mm 61.5 46 33 180g



**60° AFT HANDRAIL FITTING**

casted AISI 316

ITEM NO.	Tube O.D.	Weight
<b>009647</b>	22mm(7/8")	140g



**120° FORWARD HANDRAIL FITTING**

casted AISI 316

ITEM NO.	Tube O.D.	Weight
<b>009648</b>	22mm(7/8")	140g



**END STANCHIONS** Casted AISI 316

With thread pin

ITEM NO.	Φ	L	H	Weight/g
<b>009646</b>	36	70	86	293



**BERLEY CHOPPER**

stainless steel

ITEM NO. **B23-012**

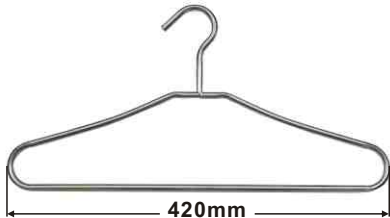

**CLOTH HANGER**

stainless steel tube

ITEM NO. **B23-045**



**LIVE BAIT WATERSCOOP T/S PUMP**

stainless steel

ITEM NO. **B23-013**



**LIVE BAIT WATERSCOOP**

stainless steel

ITEM NO. **B23-014**

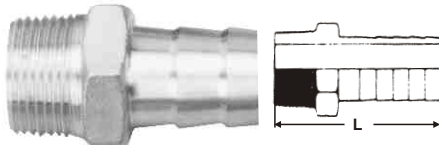

**HOSE NIPPLES (HONP)**

Threaded type: DIN 2999, NPT

ITEM NO.	SIZE	L	PACKING	MATERIAL
<b>300034</b>	3/4	72.86	150/Box	AISI 316
<b>300001</b>	1	82.46	80/Box	AISI 316

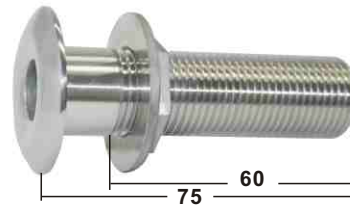

**SKIN FITTING** casted AISI 316

ITEM NO.	Size	Thread	Weight/g
<b>030012</b>	1/2"	BSP	140
<b>030034</b>	3/4"	BSP	



**90 DEGREE THRUHULL MUSHROOM HEAD BARBED**

casted AISI 316

for use with hose, not for use below the waterline

ITEM NO.	Hose size	Max Hull Thickness	Flange O.D.mm	I.D.mm	Weight/g
<b>010006</b>	19mm	27 mm	43	33	162
<b>010007</b>	25mm	29 mm	43	33	183
<b>010008</b>	38mm	30 mm	59	34.5	393



**Y VALVE** casted AISI 316

2 way

ITEM NO.	Fit hose	Weight/g
<b>010018</b>	38mm(1-1/2")	1100



**STERN ANCHOR ROLLER** AISI 304  
mounting for  $\Phi$ 22mm & 25mm rail tube with belt

ITEM NO.	$\Phi$	Length	Width	Weight
<b>003690</b>	34cm	30m	50mm	5.1kg
<b>003691</b>	38cm	50m	50mm	

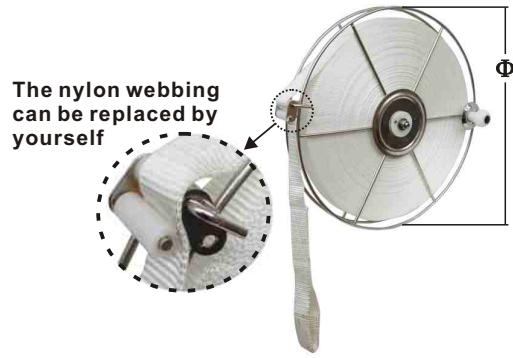

**STERN ANCHOR ROLLER** AISI 304  
mounting for  $\Phi$ 22mm & 25mm rail tube with belt

ITEM NO.	$\Phi$	Length	Width	Weight
<b>B19-040</b>	34cm	30m	50mm	5.1kg



**REEL FOR SAFETY LINE** AISI 304  
with approx 100 meters cord dia 10mm  
for recure-body vertical mount  
Roll over all 200mm  
Width 450mm  
ITEM NO. Weight/g  
**B23-027** 1800



**FASTENING SET FOR SUPS**  
With the attachment kit you can easily attach your SUP to the board ! 360 adjustable clamps made of high-strength nylon material with high degree of flexibility.  
Suitable for pipes dia. 22 to 30mm  
Snap closure length: 180cm  
ITEM NO. **B23-032**



**UNIVERSAL STRAP**  
Stainless steel buckle, polyester webbing  
25mm wide Length:200cm  
ITEM NO. Weight/g  
**003566** 70



**SPRING CLAMPS** casted AISI 316  
for boat hook  
ITEM NO. Min I.D. Weight/g  
**003116** 1"(25mm) 42



**HANDRAIL END FITTING/  
EMBOU MAIN COURANTE**

casted AISI 316

ITEM NO.	Φmm	L mm	Weight/g
<b>B23-004</b>	25	65	160

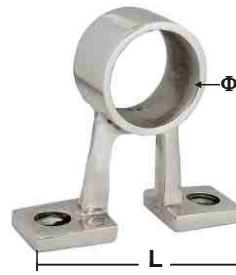

**HANDRAIL CENTER FITTING/  
PASSAGE MAIN COURANTE**

casted AISI 316

ITEM NO.	Φmm	L mm	Weight/g
<b>B23-005</b>	25	65	90



**TOP SLIDE WITH NUT** casted AISI 316

Ideal for installing bimini tops stringers for fender racks or wherever a rail mounted hinge is commonly needed

ITEM NO. Tube O.D.

**B23-002** 22mm(7/8")

**B23-003** 25mm(1")



**SNEATCH CLEAT/  
SNATCH PLATE** AISI 316  
ITEM NO. **B23-006**

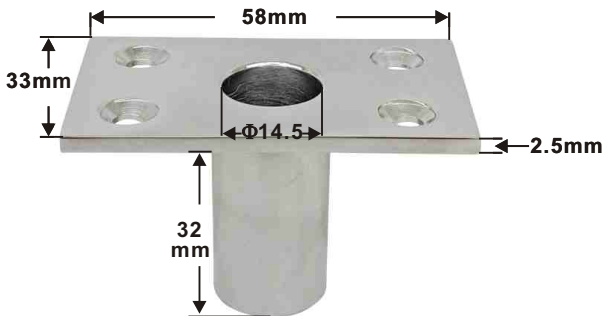

**FLUSH MOUNT POLE SOCKETS** AISI 316

Vertical sockets are typically used on the bow

ITEM NO. I.D. Weight/g

**B23-007** 14.5mm 55



**SPINNAKER POLE HOLDER** AISI 304

for Φ25mm tube Ring Φ65mm

ITEM NO. Weight/g

**B23-035** 86

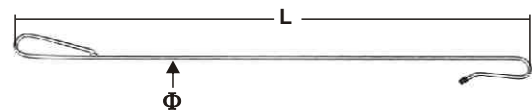

**BUOY AND LOCK HOOK** AISI 304

ITEM NO. Φmm L cm Weight/g

**020319** 10 95



**DECK THROUGH** AISI 304

Save and dry way to lead the electronic through the deck. Hole dimension Φ25mm

ITEM NO. Weight/g

**003742** 520



**STRONG BUOY HOOK** AISI 304

A very strong hook keeps your boat save on the mooring bouy, easy to pick and release the bouy.

ITEM NO. Length Weight/g

**020320** 120cm



**HOLDER FOR RESCUE DEVICE** AISI 304

fit  $\Phi$ 25mm tube rail

ITEM NO.	Size	Weight/g
<b>007936</b>	105mmx65mm	420

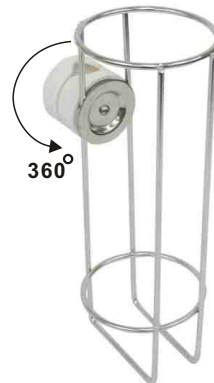

**HOLDER FOR RESCUE DEVICE** AISI 304

fit  $\Phi$ 25mm tube rail

ITEM NO.	Size	Weight/g
<b>007941</b>	$\Phi$ 95mmx300mm	440



**FENDER HOLDER** AISI 304

ITEM NO.		Weight
<b>007938</b>	$\Phi$ 135mm for 125mm(5") double fenders	625g
<b>007939</b>	$\Phi$ 160mm for 150mm(6") double fenders	730g
<b>007940</b>	$\Phi$ 230mm for 200mm(8") double fenders	960g

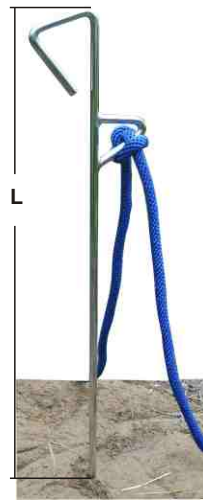

**SAND SPIKES**

An alternative to more expensive beach and land anchoring devices, this rod securely holds watercraft up to 26 feet (8 meter). Simply push into the ground, or use a hammer in firmer soils, and attach an anchor line to the attachment loop.

ITEM NO.	L cm	Material
<b>020321</b>	86	Steel chrome
<b>020322</b>	86	AISI 304

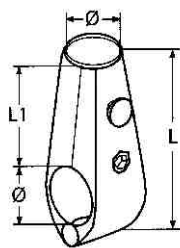

**RAIL MOUNT FLAG POLE SOCKET**

casted AISI 316

ITEM NO.	for tube- $\Phi$	L	L1
<b>B22-004</b>	25mm	20mm	40mm



**FLAG POLE 45°** AISI 316

Staffs come completely with stainless steel the pole of sockets is 60cm(23-1/2")

ITEM NO.	Base	Weight
<b>009815</b>	98mm x 28mm	422g



**FLAG POLE 10°** AISI 316

staffs come complete with stainless steel socket, the pole is 43cm(17").

ITEM NO.	Base	Weight
<b>009636</b>	98mm x 28mm	280g



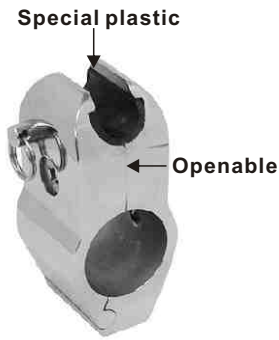

**OPENABLE JAW SLIDE** casted AISI 316  
special plastic inserts ensure smooth movement & tight rattle free fit. Include pin. Base for top cap with ball end.

ITEM NO.	Tube O.D.	Weight/g
<b>009690</b>	25mm(1")	260



**FLAT BASE** casted AISI 316  
special plastic inserts ensure smooth movement & tight rattle free fit. Include pin & lanyards. Base for top cap with ball end.

ITEM NO.	Base mm	Weight/g
<b>009691</b>	93x40	161



**QUICK RELEASE BIMINI** casted AISI 316

Adjustable angle

ITEM NO.	L mm	Weight/g
<b>009631</b>	90	150



**QUICK RELEASE FOR WEBBING** casted AISI 316

Adjustable angle

ITEM NO.	L mm	W mm	Weight/g
<b>009634</b>	90	25(1")	180
<b>009639</b>	90	30(1-1/6")	180



**QUICK RELEASE UNIVERSAL DECK HINGE** casted AISI 316

Adjustable angle

ITEM NO.	L mm	Weight/g
<b>009629</b>	90	165



**FIXING PLATE WITH QUICK RELEASE** casted AISI 316

Disingadge turning the central part.

ITEM NO.	Base mm	Tube O.D.	Weight/g
<b>009640</b>	89x32	22mm(7/8")	320
<b>009641</b>	89x32	25mm(1")	250
<b>009642</b>	89x32	30mm(1-3/16")	300

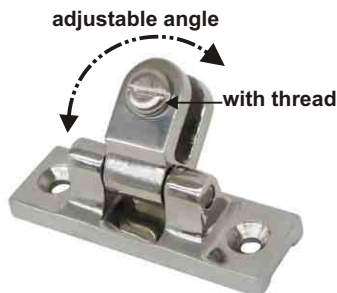

**UNIVERSAL DECK HINGE** casted AISI 316

ITEM NO.	Base	Weight/g
<b>B19-009</b>	62x21mm(2-5/8"x1-1/8")	100



**GRAB HANDLE CONNECTION**

stamped AISI 316

ITEM NO.	L mm	D mm	Weight/g
<b>009656</b>	90(3-1/2")	22(7/8")	
<b>009664</b>	90(3-1/2")	25(1")	

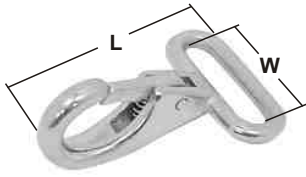

**CARBINE HOOK** AISI 316  
 ITEM NO. L mm W mm Weight/g  
**000407** 50(2") 25(1") 25



**SNAP HOOK WITH BUCKLE** AISI 316  
 ITEM NO. L mm W mm Weight/g  
**000409** 70(2-3/4") 25(1") 43

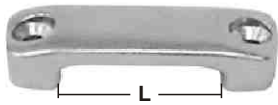

**FOOTMAN LOOPS FOR STRAPS**  
 Casted AISI 316  
 ITEM NO. L mm Weight/g  
**008428** 28.5 31  
**008429** 30 31  
**008431** 40 40



**CENTER STANCHIONS** Casted AISI 316

Open

ITEM NO.	Φ	L	H	Weight/g
	mm	mm	mm	
<b>009645</b>	36	70	86	292



**90° ELBOW** casted AISI 316  
ITEM NO. Tube O.D. Weight  
**009686** 40mm(1-9/16")



**60° ROUND BASE** casted AISI 316  
ITEM NO. Tube O.D. Weight  
**009687** 40mm(1-9/16")



**60° UNIVERSAL TEE** casted AISI 316  
ITEM NO. Tube O.D. Weight  
**009684** 40mm(1-9/16")



**90° TEE SLEEVE** casted AISI 316  
ITEM NO. Tube O.D. Weight  
**009694** 40mm(1-9/16")



**RAIL FITTING WITH DISTANCE**  
Attachment 20x17mm AISI 316  
ITEM NO. Φmm  
**B18-022** 22  
**B18-023** 25

## NEW SIZE: 32mm SERIES



**90° ROUND BASE** casted AISI 316  
ITEM NO. Tube O.D. Base Weight/g  
**009609** 32mm(1-1/4") 75mm 260



**60° ROUND BASE** casted AISI 316  
ITEM NO. Tube O.D. Base Weight/g  
**009612** 32mm(1-1/4") 75mm 260



**60° RECTANGULAR BASE** casted AISI 316  
ITEM NO. Tube O.D. Base mm Weight/g  
**009617** 32mm(1-1/4") 82x42 250



**90° ELBOW** casted AISI 316  
ITEM NO. Tube O.D. Weight/g  
**009649** 32mm(1-1/4") 250



**60° UNIVERSAL TEE** casted AISI 316  
ITEM NO. Tube O.D. Weight/g  
**009669** 32mm(1-1/4") 300

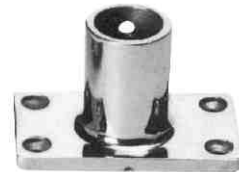

**90° RECTANGULAR BASE** casted AISI 316  
ITEM NO. Tube O.D. Base mm Weight/g  
**009678** 32mm(1-1/4") 82x42 250



**90° TEE** casted AISI 316  
ITEM NO. Tube O.D. Weight/g  
**009696** 32mm(1-1/4") 250



**FISHING ROD HOLDER** casted AISI 316  
Adjustable from 22mm(7/8") up to 30mm  
(1-3/16") round rails.

ITEM NO.	Length	I.D.	Weight/g
<b>009644</b>	250mm(10")	50mm(2")	1305

Adjustable 22~30mm



**CLAMP ON ROD HOLDER** casted AISI 316  
Adjustable for 7/8" or 1" round rails  
mountable on vertical or horizontal rails.  
with plastic knob screw.

ITEM NO.	Length	I.D.	Weight/g
<b>009667</b>	9"	1-1/2"	560



**CLAMP ON ROD HOLDER** casted AISI 316  
Adjustable up to 32mm round rail tube  
mountable on vertical or horizontal rails

ITEM NO.	Length	I.D.	O.D.
	mm	mm	mm
<b>009666</b>	245(9-5/8")	40(1-1/2")	65(2-1/2")

Can fit rail tube  $\Phi$ 25mm up to  $\Phi$ 32mm



**CLAMP ON ROD HOLDER** casted AISI 316  
Adjustable up to 32mm round rail tube  
mountable on vertical or horizontal rails

ITEM NO.	Length	I.D.	Weight/g
<b>009697</b>	9"	42mm	610

Can fit up to rail tube  $\Phi$ 32mm



**ROD HOLDER HANGER SET**

casted AISI 316

ITEM NO.	Weight
<b>009665</b>	320g

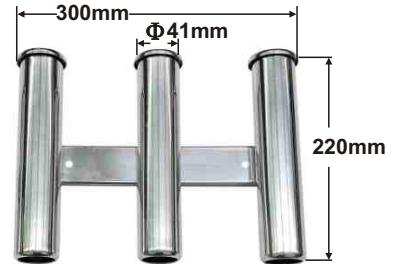

**ROD HOLDER FOR 3 FISHING ROD**

Made of stainless steel tube AISI 304

ITEM NO.	Length
<b>B23-053</b>	300mm



**NO.009576**

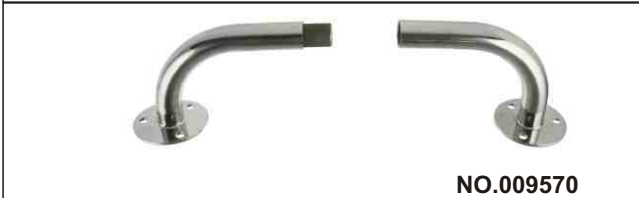

**NO.009570**

**SMART ROD HOLDER SYSTEM** AISI 304

You can set up the rod holder according your demand any Qty any angle.

Rod holder I.D.:40mm. Can fit fishing reel.

Patent pending.

ITEM NO.	Description	L mm	Weight/g
<b>009570</b>	rod holder mounting	175	630
<b>009576</b>	rod holder triple + mounting	920	2130

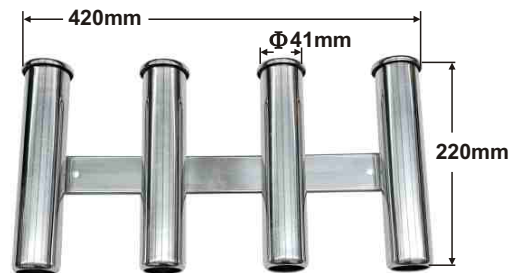

**ROD HOLDER FOR 4 FISHING ROD**

Made of stainless steel tube AISI 304

ITEM NO.	Length
<b>B23-054</b>	420mm



**OVAL GRAB RAILS** AISI 304

ITEM NO.	Length	Weight/g
<b>002271</b>	9"(23cm)	134
<b>002272</b>	12"(30cm)	179
<b>002273</b>	18"(46cm)	234
<b>002274</b>	24"(61cm)	329



**HANDLE** high polish AISI 316

ITEM NO.	L mm	H mm	Weight/g
<b>002228</b>	250	30	
<b>002229</b>	300	30	
<b>002230</b>	400	30	400
<b>002231</b>	500	30	
<b>002232</b>	600	30	
<b>002233</b>	700	30	

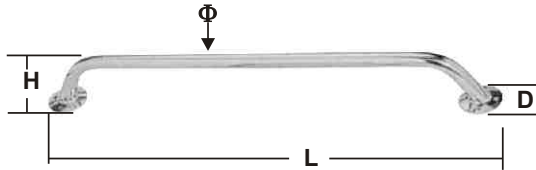

**HANDLE** AISI 304

ITEM NO.	L mm	H mm	D mm	Φmm
<b>002240</b>	400	75	51	20
<b>002260</b>	600	75	51	20

*on request AISI 316*

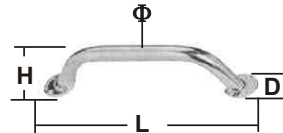

**HANDLE** AISI 304

ITEM NO.	L mm	H mm	D mm	Φmm
<b>002227</b>	270	65	40	20

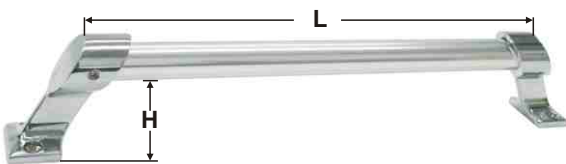

**HANDRAIL** AISI 304

ITEM NO.	L mm	H mm	Weight
<b>002225</b>	300(12")	42	420g
<b>002226</b>	400(18")	42	514g

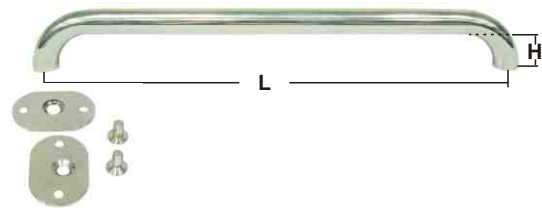

**HANDLE** high polish AISI 304

Include mounting plate, screw

ITEM NO.	L mm	H mm
<b>002219</b>	300	40
<b>002220</b>	450	40



**PULL HANDLES** AISI 304

solid stainless steel rod, satin finished, pull features a stylish look and easy grip design features ample hand clearance. Ideal for cabinets and drawers of all varieties. (Less screw)

ITEM NO.	L mm	Rod Dia mm	Thread	Weight/g
<b>002202</b>	76 (3")	10	M4	55
<b>002203</b>	90 (3-1/2")	10	M4	81
<b>002204</b>	102(4")	8	M4	

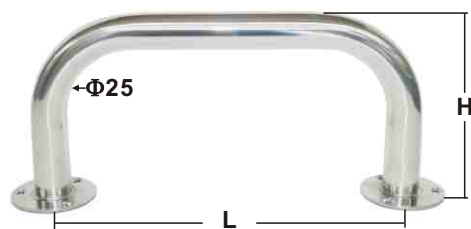

**HANDLE** AISI 316

ITEM NO.	L mm	H mm	Weight
<b>B16-006</b>	250	135	480g

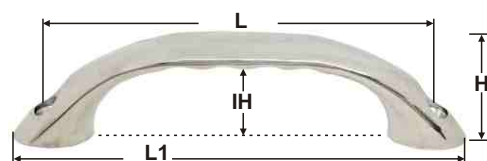

**HANDLE** AISI 316

ITEM NO.	L mm	L1 mm	IH mm	H mm	Weight/g
<b>B23-026</b>	141	170	32	40	230

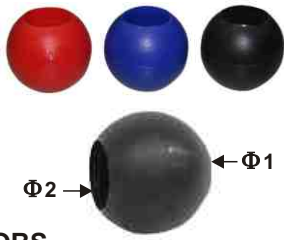

**STOPPER KNOBS**

Nylon plastic  
ITEM NO.

	Φ1 mm	Φ2 mm	Color	Weight/g
<b>072406-1</b>	6	12.5	red	4
<b>072406-2</b>	6	12.5	blue	4
<b>072406-4</b>	6	12.5	black	4



**SINGLE STEP LADDER** AISI 316

With non-slip plastic cover and 4 pcs plastic plates which can be adjusted to different degree.

ITEM NO.	Length	Weight
<b>000738</b>	30 cm	580g



**3 STEPS TELESCOP WITH GRAB HANDLES** AISI 316

Mounting on the plat form with grab handles for easy entry.

ITEM NO.	Length Deployed	Length stowed	Height	Width
<b>000739</b>	34" (86cm)	14.5" (37cm)	15" (38cm)	12.5" (32cm)



**PLAT FORM TELESCOPING 3 DROP LADDER** AISI 316

ITEM NO.	Length Deployed	Length stowed	Height	Width	Bracket Length	Weight
<b>000736</b>	34" (86cm)	16" (41cm)	16" (41cm)	12.5" (32cm)	5cm	3.5kg



**3 STEP TELESCOPE BOW LADDER** AISI 316

For a range of Bruce/M-Anchor from 7,5kg up to 20kg  
Easy adjustable for any size from 7,5kg up to 20kg.

ITEM NO.	Weight/g
<b>000737</b>	3775

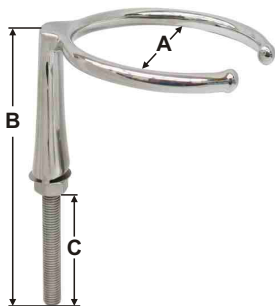

**CUP AND BOTTLE HOLDER** AISI 316

ITEM NO.	A mm	B mm	C mm	Model	Width/g
<b>B19-001</b>	88	150	80	single	310

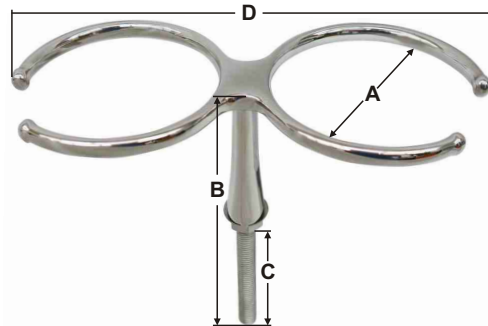

**CUP AND BOTTLE HOLDER** AISI 316

ITEM NO.	A mm	B mm	C mm	D mm	Model	Width/g
<b>B19-002</b>	88	150	80	210	double	420



**TOP CAP DECK FITTING FOR WINCH**  
 casted AISI 316  
 ITEM NO. **B18-002**



**CHAIN STOPPER** casted AISI 316  
 For chain 1/4"(6mm) to 5/16"(8mm) removable  
 pawl flips up when not in use  
 ITEM NO. Base measure mm Width/g  
**000117** 2-1/4"(58)x2-1/8"(54)x1-13/16"(47)H 300



**CHAIN CLAW** casted AISI 316  
 ITEM NO. Chain mm Weight/g  
**002303** 6-8 280



**ANCHOR LOCK** AISI 316  
 Channel lock secures anchors  
 against accidental deployment.  
 Dia 6mm locking pin locks shackle  
 or chain to 10mm in place.  
 ITEM NO. L mm W mm H mm  
**000141** 100 35 35



**STAINLESS STEEL DRINK HOLDER**  
 Gimbaled caddy holds beverage cans,  
 bottles and glasses level. Includes insulated  
 cozy and clip for flat surface mounting.  
 ITEM NO. Box  
**007798** 50

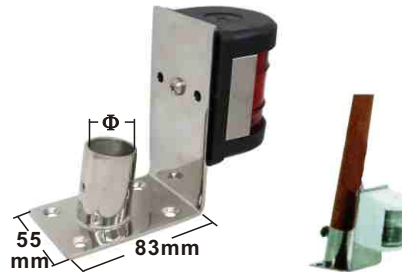

**FLAG AND NAVIGATION LIGHT**  
**SOCKETS** AISI 304 (Less navigation light)  
 ITEM NO. Φmm Weight  
**B18-018** 25 190g

## OPTIMIST COLLECTION

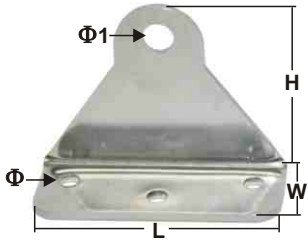

### PLATE FITTING FOR RUDDER OPTIMIST

stamped AISI 304

ITEM NO.	L	W	H	Φ	Φ1	Weight/g
	mm	mm	mm	mm	mm	
<b>008741</b>	50	21	38	4.1	6.1	30

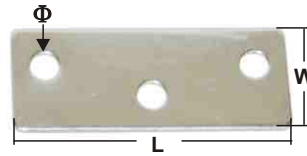

### PLATE FOR OPTIMIST stamped AISI 304

ITEM NO.	L	W	Φ	Weight/g
	mm	mm	mm	
<b>008751</b>	50	20	5.5	10

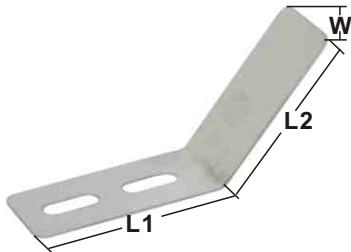

### SPRING PLATE FOR OPTIMIST stamped AISI 304

ITEM NO.	L1	L2	W	Weight/g
	mm	mm	mm	
<b>008761</b>	42	38	19	10



### FITTING FOR OPTIMIST stamped AISI 304

ITEM NO.	L	W	Φ	Weight/g
	mm	mm	mm	
<b>008762</b>	62	24.5	4.5	10

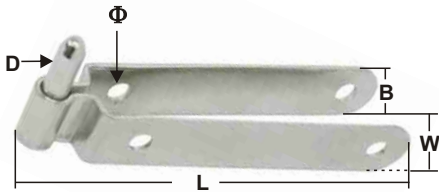

### RUDDER FITTING FOR OPTIMIST

stamped AISI 304

ITEM NO.	L	B	D	W	Φ	Weight/g
	mm	mm	mm	mm	mm	
<b>008795</b>	95	15	6	13.1	5.1	40

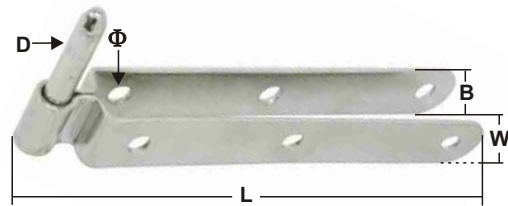

### RUDDER FITTING FOR OPTIMIST

stamped AISI 304

ITEM NO.	L	B	D	W	Φ	Weight/g
	mm	mm	mm	mm	mm	
<b>008796</b>	120	15	6	13.1	5.1	50

008741

008751

008762



008795

008796

### RUDDER FITTING SET

Include 008741x2, 008751x2, 008762x2, 008795x2, 008796x2

ITEM NO.	Weight/g
<b>008700</b>	280



### ADJUSTABLE MAST STEP AISI 304

Round type with stainless steel spring which prevents the nut from turning accidentally

ITEM NO.	Weight/g
<b>008702</b>	310



**CURVED PIN FOR OPTIMIST**

AISI 304

ITEM NO.	L mm	Φ mm	Weight/g
<b>008704</b>	35	5	10

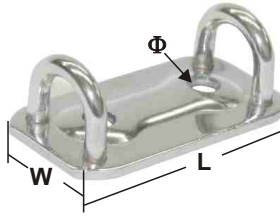

**DECK PLATE FOR OPTIMIST**

Stamped AISI 304

ITEM NO.	L mm	W mm	Φ mm	Weight/g
<b>008705</b>	50	26	5.5	20

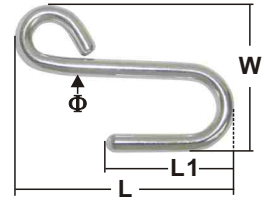

**S HOOK** AISI 304

ITEM NO.	Φ mm	L mm	L1 mm	W mm	Weight/g
<b>004026</b>	5	60	34	38	20



**TILLER CLAMP**

Stamped AISI 304

ITEM NO.	L mm	Weight/g
<b>008763</b>	78	50



**SWIVEL FOR OPTIMIST**

AISI 304

ITEM NO.	L mm	W mm	Weight/g
<b>008764</b>	40	12	20



**RAILING LEAD** AISI 304

ITEM NO.	L mm	Weight/g
<b>008765</b>	70	45

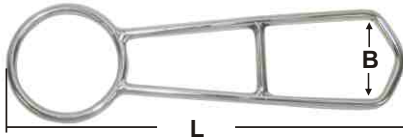

**TRAPEZE RING WITH BAR**

AISI 304

ITEM NO.	L mm	B mm	Weight/g
<b>004634</b>	200	35	72

on request AISI 316



**MAST CLIP** AISI 304

For optimist boat stainless steel clip covered with neoprene

ITEM NO.	Weight/g
<b>008701</b>	50

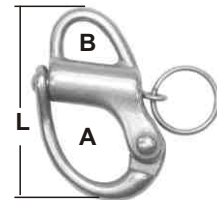

**MINI FIXED SNAP** AISI 316

ITEM NO.	A mm	B mm	L mm	Weight/g
<b>001511</b>	10	7	32	10

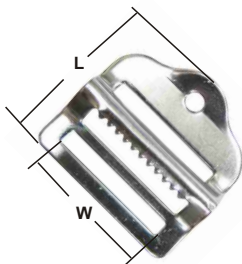

**BUCKLE** AISI 316

ITEM NO.	L mm	W mm	Weight/g
<b>004323</b>	34(1-5/16")	25(1")	10

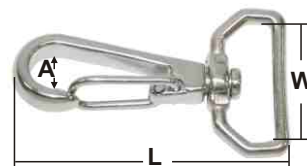

**WEB SWIVEL SNAP HOOK** Casted AISI 316

ITEM NO.	A mm	L mm	W mm	Weight/g
<b>000411</b>	9	65	28	30

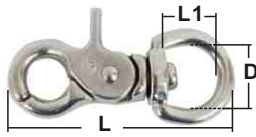

**TRIGGER SNAP WITH SWIVEL EYE** AISI 316  
 ITEM NO. L L1 D  
 mm mm mm  
**B19-034** 46 12 14

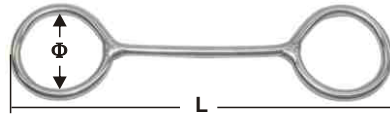

**DOG BONE** AISI 304  
 ITEM NO. L Φ  
 mm mm Weight/g  
**B17-008** 153 31 45

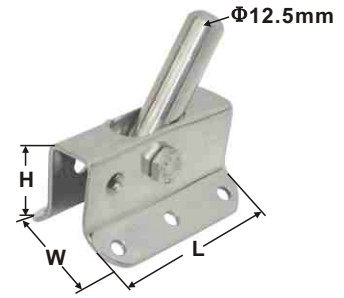

**MAST FITTING**  
 Stamped AISI 304  
 ITEM NO. L H W  
 mm mm mm Weight/g  
**B17-009** 65 35 42 140

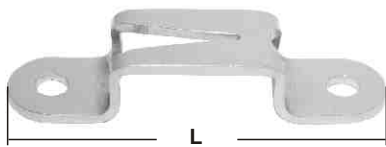

**V CLEAT** AISI 304  
 For school masts and booms  
 ITEM NO. L mm  
**008703** 50

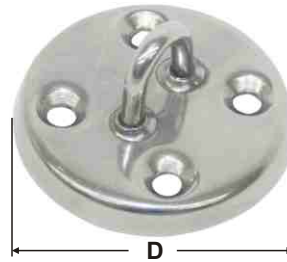

**SWIVEL BASE** stamped AISI 304  
 ITEM NO. Dmm Weight/g  
**005061** 55 40



**SWIVEL BASE** stamped AISI 304  
 ITEM NO. L mm W mm Weight/g  
**005063** 50 26

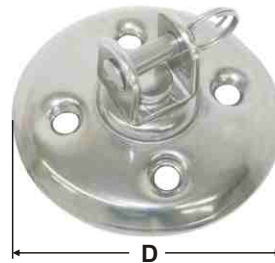

**SWIVEL BASE** stamped AISI 304  
 ITEM NO. D mm Weight/g  
**005062** 58(2-1/4") 50

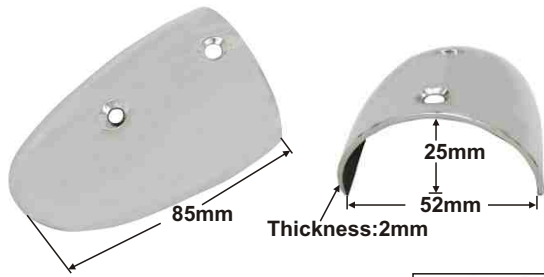

**FENDER STRIP** AISI 316  
To mount on support PVC UV bases  
ITEM NO. **B23-010**



PVC UV resistant bases

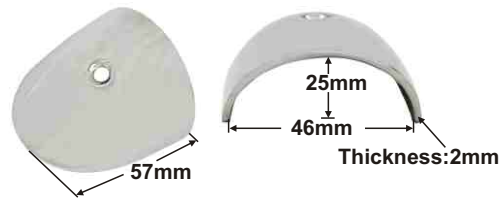

**FENDER STRIP** AISI 316  
To mount on support PVC UV bases  
ITEM NO. **B23-011**



PVC UV resistant bases

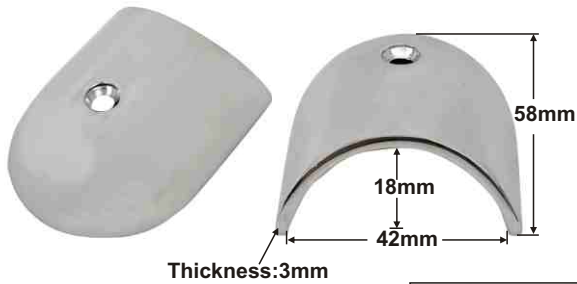

**FENDER STRIP** AISI 316  
To mount on support PVC UV bases  
ITEM NO. **B23-020**



PVC UV resistant bases



**FENDER STRIP** AISI 316  
To mount on support PVC UV bases  
ITEM NO. **B23-021**



PVC UV resistant bases

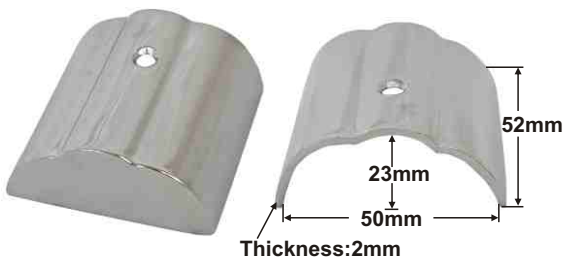

**FENDER STRIP** AISI 316  
To mount on support PVC UV bases  
ITEM NO. **B23-022**



PVC UV resistant bases

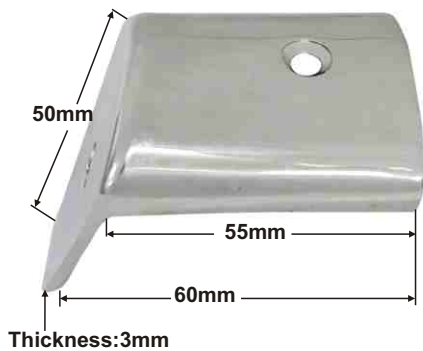

**FENDER STRIP** AISI 316  
To mount on support PVC UV bases  
ITEM NO. **B23-024**



PVC UV resistant bases



**FENDER STRIP** AISI 316  
To mount on support PVC UV bases  
ITEM NO. **B23-023**



PVC UV resistant bases



**LOW-PROFILE ANTENNA RATCHET MOUNTS WITH HANDLE** casted AISI 316  
installation on rails of 7/8"(22mm) and 1"(25mm).

ITEM NO.	Thread	Weight/g
<b>009693</b>	1"~14"	600



**LOW-PROFILE ANTENNA RATCHET MOUNTS** casted AISI 316  
no handle installation on rails of 7/8"(22mm) and 1"(25mm).

ITEM NO.	Thread	Weight/g
<b>009692</b>	1"~14"	450



**ANTENNA RATCHET MOUNTS** casted AISI 316  
Socket 4-way ratchet design for mounting versatility.  
With cable run.

ITEM NO.	Base	Thread	Weight
<b>009896</b>	2-1/4"x3-1/2"	1"-14	640g economic

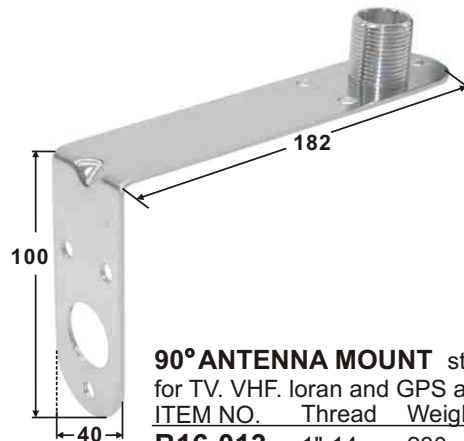

**90° ANTENNA MOUNT** stamped AISI 304  
for TV. VHF. Ioran and GPS antennas

ITEM NO.	Thread	Weight
<b>B16-013</b>	1"-14	230g

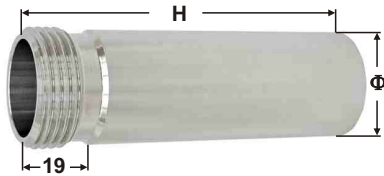

**STAINLESS STEEL EXTENSIONS**

For metal GPS bases.

ITEM NO.	Tube $\phi$	Threaded	H mm	Weight/g
<b>B23-008</b>	32mm	1"	100	208

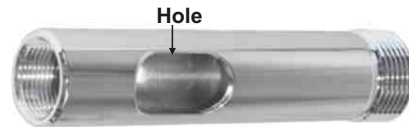

**STAINLESS STEEL EXTENSIONS WITH HOLE**

For metal GPS bases.

ITEM NO.	Tube $\phi$	Threaded	H mm	Weight/g
<b>B23-055</b>	32mm	1"	100	208

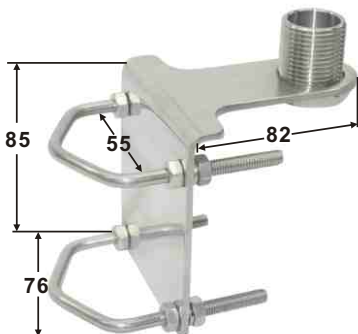

**90° ANTENNA MOUNT** stamped AISI 304  
for TV. VHF. Ioran and GPS antennas

ITEM NO.	Thread	fit Tube	Maximum
<b>B16-011</b>	1"-14	$\phi$ 55mm	



**ECONOMY RAIL MOUNT** stamped AISI 304  
Fit 22mm(7/8") or 25mm(1")

ITEM NO.	Thread	Weight/g
<b>009689</b>	1"-14	140



**UNIVERSAL MOUNT** AISI 316  
For GPS/UKW antennae Hinght:100mm(4")

ITEM NO.	Thread	Weight/g
<b>009871</b>	1"-14	300

ITEM NO.	PAGE	ITEM NO.	PAGE	ITEM NO.	PAGE	ITEM NO.	PAGE
000117	A23	002271	A21	003781	A7	007938	A16
000141	A23	002272	A21	003794	A8	007939	A16
000317	A1	002273	A21	003795	A7	007940	A16
000318	A1	002274	A21	003797	A9	007941	A16
000319	A1	002303	A23	003871	A10	008020	A1
000407	A18	003014	A3	003874	A10	008021	A1
000409	A18	003017	A3	003876	A10	008022	A1
000411	A25	003116	A14	003889	A10	008023	A1
000736	A22	003129	A3	003891	A10	008024	A1
000737	A22	003406	A1	003892	A10	008311	A3
000738	A22	003408	A1	004026	A25	008319	A2
000739	A22	003410	A1	004213	N1	008340	A2
001306-P	A1	003566	A14	004214	N1	008348	A3
001308-P	A1	003590	A11	004215	N1	008399	A3
001310-P	A1	003591	A11	004323	A25	008428	A18
001511	A25	003592	A11	004502	A7	008429	A18
001800	A1	003597	A12	004634	A25	008431	A18
001801	A1	003598	A12	004900	A11	008511	A6
001802	A1	003599	A12	004901	A11	008512	A6
001803	A1	003684	A1	004902	A11	008513	A5
001816	A1	003687	A4	004903	A11	008514	A5
001817	A1	003688	A1	005061	A26	008515	A6
001818	A1	003690	A14	005062	A26	008516	A5
001819	A1	003691	A14	005063	A26	008614	A4
002202	A21	003692	A11	005733	A2	008700	A24
002203	A21	003693	A11	005747	A2	008701	A25
002204	A21	003695	A12	005750	A2	008702	A24
002219	A21	003696	A12	005757	A2	008703	A26
002220	A21	003697	A12	006131	A12	008704	A25
002225	A21	003698	A4	006132	A5	008705	A25
002226	A21	003740	A9	006133	A12	008741	A24
002227	A21	003742	A15	006134	A5	008751	A24
002228	A21	003743	A9	006135	A12	008761	A24
002229	A21	003744	A9	006137	A6	008762	A24
002230	A21	003750	A9	006138	A5	008763	A25
002231	A21	003751	A8	006139	A5	008764	A25
002232	A21	003752	A9	007109	A8	008765	A25
002233	A21	003775	A9	007179	A8	008795	A24
002240	A21	003777	A7	007798	A23	008796	A24
002260	A21	003780	A7	007936	A16	008858	A7

ITEM NO.	PAGE	ITEM NO.	PAGE	ITEM NO.	PAGE	ITEM NO.	PAGE
008887	A7	009689	A28	B18-023	A19	B23-002	A15
008888	A7	009690	A17	B19-001	A22	B23-003	A15
008889	A7	009691	A17	B19-002	A22	B23-004	A15
008893	A7	009692	A28	B19-004	A10	B23-005	A15
008894	A7	009693	A28	B19-005	A10	B23-006	A15
008895	A7	009694	A19	B19-006	A10	B23-007	A15
008930	A7	009696	A19	B19-007	A10	B23-008	A28
008931	A7	009697	A20	B19-009	A17	B23-009	A11
008932	A7	009815	A16	B19-010	A7	B23-010	A27
008933	A7	009871	A28	B19-011	A7	B23-011	A27
009570	A20	009896	A28	B19-012	A7	B23-012	A13
009576	A20	010006	A13	B19-013	A7	B23-013	A13
009609	A19	010007	A13	B19-015	A10	B23-014	A13
009612	A19	010008	A13	B19-016	A10	B23-020	A27
009617	A19	010018	A13	B19-017	A4	B23-021	A27
009629	A17	020319	A15	B19-018	A8	B23-022	A27
009631	A17	020320	A15	B19-019	A12	B23-023	A27
009634	A17	020321	A16	B19-020	A12	B23-024	A27
009636	A16	020322	A16	B19-024	A11	B23-025	A3
009639	A17	030012	A13	B19-025	A11	B23-026	A21
009640	A17	030034	A13	B19-026	A11	B23-027	A14
009641	A17	072406-1	A22	B19-027	A4	B23-029	A2
009642	A17	072406-2	A22	B19-028	A6	B23-030	A2
009644	A20	072406-3	A22	B19-029	A9	B23-032	A14
009645	A19	073507	A11	B19-030	A3	B23-034	A9
009646	A13	2431-SS	A6	B19-033	A4	B23-035	A15
009647	A13	300001	A13	B19-034	A26	B23-036	A10
009648	A13	300034	A13	B19-035	A4	B23-041	A9
009649	A19	B16-006	A21	B19-039	A12	B23-045	A13
009656	A17	B16-011	A28	B19-040	A14	B23-049	A11
009664	A17	B16-013	A28	B19-045	A4	B23-050	A3
009665	A20	B17-002	N4	B19-046	A4	B23-053	A20
009666	A20	B17-008	A26	B22-001	A6	B23-054	A20
009667	A20	B17-009	A26	B22-004	A16	B23-055	A28
009669	A19	B18-002	A23	B22-005	A1	B24-001	N4
009678	A19	B18-013	A12	B22-007	A8	B24-002	N4
009684	A19	B18-015L	A5	B22-008	A8	B24-004	N5
009686	A19	B18-015R	A5	B22-009	A4	B24-006	N4
009687	A19	B18-018	A23	B22-010	A8	B24-008	N5
009688	A8	B18-022	A19	B22-019	N3	B24-009	N5

ITEM NO.	PAGE
B24-010	N5
B24-011	N6
B24-012	N6
B24-013	N4
B24-016	N4
B24-017	N4
B24-018	N4
B24-019	N4
B24-020	N4
B24-022	N4
B24-023	N6
B24-024	N6
B24-026	N6
B24-027	N3
B24-028	N5
B24-029	N5
B24-037	N6
B24-038	N6
B24-039	N6
B24-040	N6
B24-043	N2
B24-044	N2
B25-002	N3
B25-004	N1
B25-008	N2
B25-009	N2
B25-010	N2
B25-011	N2
B25-012	N1
B25-013	N1
B25-014	N1
B25-015	N1
B25-016	N2
B25-017	N2
B25-018	N2
B25-019	N2
B25-020	N1
B25-021	N2
B25-024	N3